



WATTS
SunTouch

Space Warming Manual

D12 Series

Roll out the mat, make
your turns, fasten it
down, and set the tile!

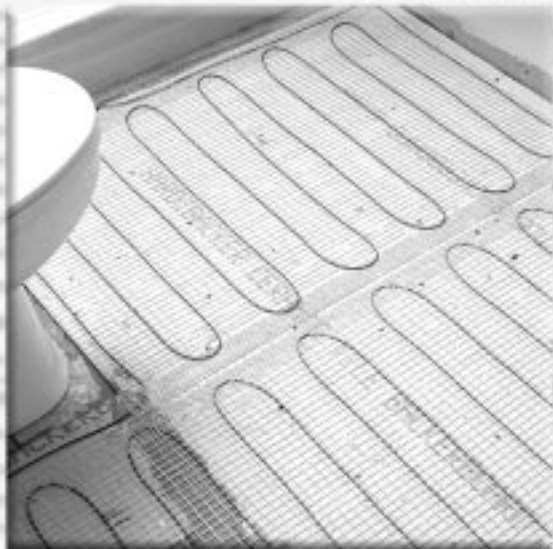

36" width

24" width

12" width



*There's no easier way to heat a
floor than with SunTouch.*

*If you have any difficulties or
questions when installing our product,
just give us a call. We're here to help!*

888-432-8932

www.suntouch.net



**Made in the
USA**

Welcome to SunTouch!

SunTouch floor-warming mats have several great features that make make any installation fast and easy.

- The S-pattern of SunTouch's blue heating wire means you can make both right and left turns easier and faster.
- SunTouch's blue heating elements are tough and resistant to jobsite abuse.
- SunTouch is the only electric floor-warming product manufactured in America that registers no measurable electromagnetic field (EMF)*.
- SunTouch comes with an armored "power lead" that makes for a tougher and safer connection to the controls.
- With a slight change in the mat output, SunTouch is now more efficient than ever.

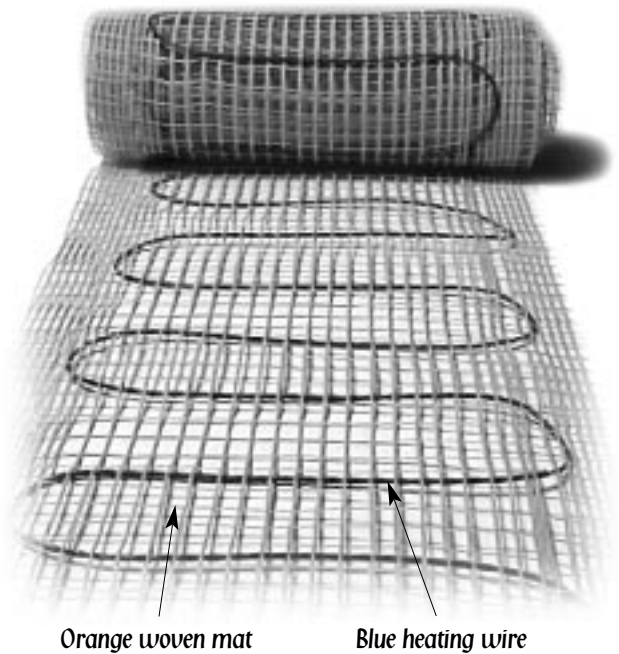

Orange woven mat

Blue heating wire

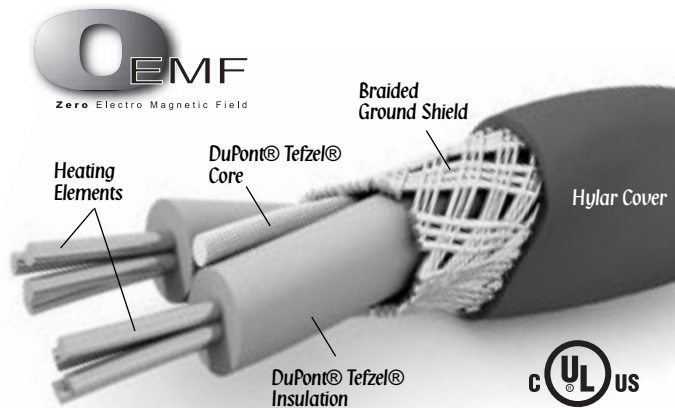

Enlarged, cutaway view of the blue heating wire.

The SunTouch Mat: The blue heating wire is woven into a special orange fiber to make rectangular mats. These mats are manufactured for 120 VAC and 240 VAC, in 12", 24", and 36" widths. Mats range from 10 sq.ft. to 160 sq.ft., depending on width, length and voltage. Mats of different dimensions must be wired together in parallel (not series) to fill larger areas. However, they must be the same voltage. For example, to warm an 80 sq.ft. area, many combinations are possible: two 12" x 40' mats; or even a combination of one 24" x 20' and one 12" x 40'. Never combine 120 VAC mats with 240 VAC mats.

SunTouch is a safe and efficient electric floor-warming product for interior applications. It cannot be used for exterior snowmelting applications. It is generally intended for installation below tile, stone, and other masonry flooring materials in residential and moderate commercial installations. SunTouch can be used to heat a room, as well as warm the floor, provided the heat loss of the room falls below the mat's capabilities. Please refer to specific design information provided for heating applications, especially when installing non-masonry

flooring materials. The designer must determine if the output of the SunTouch is enough heat to match the heat loss of the structure.

SunTouch is designed to deliver 12 W/sq.ft. The floor temperature attainable is dependent on how well the floor is insulated, the temperature of the floor before start up, and in the case of uninsulated slab applications, the thermal drain of the underlying materials. Please refer to your designer if you have further questions regarding the surface temperature you can expect from SunTouch in your particular construction.

NOTE: SunTouch has been tested to the American Standard Test Method ASTM C627, a standard test method for evaluating ceramic floor tile installation systems using the Robinson-Type Floor Tester. This test was performed by The Tile Council of America for installation above a concrete slab and above a framed floor. This testing resulted in a rating of "Moderate Commercial" for normal (non-vehicular) commercial and light institutional use. This would include all (non-vehicular) residential use as well.

Never install SunTouch directly below vinyl, carpet, or wood flooring. SunTouch must be embedded in mortar, per UL requirements. Do not use glues or adhesives. Non-masonry flooring materials such as carpet, vinyl, or hardwood can be installed over SunTouch if the mat is installed in a cement-based or gypsum-based material.

If you have any questions, please view our Installation Video, visit our Web site at www.suntouch.net, or call us at 888-432-8932.

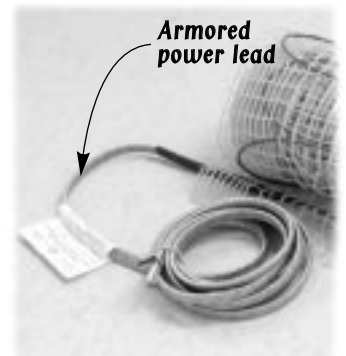

Armored power lead

*When measured at 1/2" above floor surface with a field EMF meter. SunTouch Internal Test Labs results (not verified by UL).

Here's What You'll Need:

The primary components of the SunTouch system, depending on the project requirements, are:

1. SunTouch mat*
2. Floor-sensing thermostat (programmable or non-programmable)*†
3. GFCI breaker (if not part of the thermostat)
4. External contactor (if required)

Other items needed:

- SunTouch Installation Kit* (shown below)
- Pneumatic stapler and hot glue gun
- 2-1/8" deep, 4" square electrical box for thermostat
- Single-gang "mud" (sheet rock) ring for 4" square box
- 12-gauge electrical wiring
- LoudMouth monitor*
- Digital ohm meter (multi-meter)
- Tile installation products (mortar, backer board, tile, etc.)
- 3/8" x 1/4" or greater trowel and other tile tools
- Various electrical and construction tools: (wire stripper, screwdriver, chisel, scissors, etc.)
- Insulation (if required per design)

* Items available from SunTouch. All other items are not included and can be purchased locally.

† The FloorStat is approved for use in U.S. and Canada, separate from the SunTouch Listed assembly.

SunTouch Installation Kit

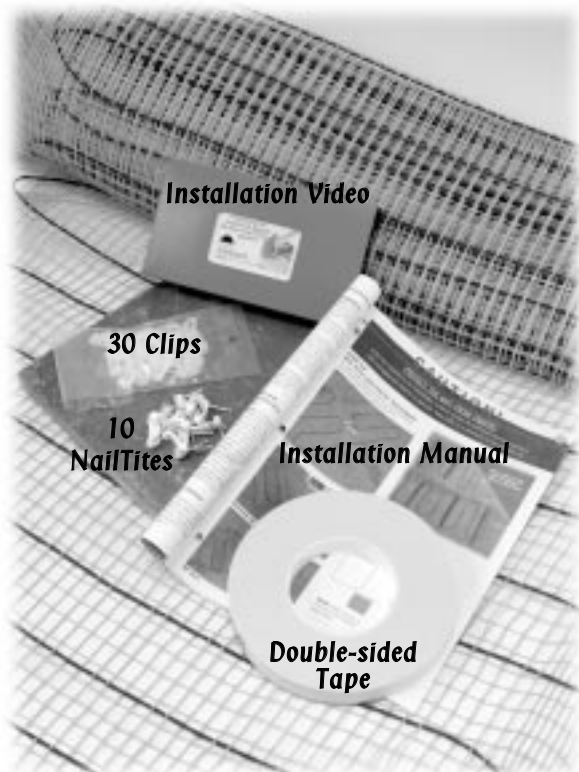

CAUTIONS!

READ BEFORE INSTALLING SUNTOUCH

NEVER install SunTouch under carpet, wood, vinyl, or other non-masonry flooring without thin-set, thick-set, or self-leveling mortar.

NEVER install SunTouch in any walls.

NEVER bang a trowel on the mat or blue wire to remove excess mortar from it.

NEVER cut the blue heating wire.

NEVER cut the mats to make them shorter.

NEVER attempt to repair the blue heating wire if it is damaged. Call the factory for further instruction.

NEVER install one mat on top of another or overlap the mat on itself. This will cause dangerous over-heating.

NEVER install SunTouch in adhesives or glues intended for vinyl tile or other laminate flooring. It must be embedded in cement-based ceramic tile mortar.

NEVER forget to install the floor sensor (if using the SunTouch FloorStat Control).

NEVER install mats under cabinets or other built-ins. Excessive heat will build up under these items.

NEVER remove the nameplate label at the end of the mat.

ALWAYS enter mat resistance in the log before, during, and after the installation process.

ALWAYS pay close attention to voltage and amp requirements of the breaker, the thermostat, and the SunTouch mat. For instance, do not supply 240 VAC to 120 VAC SunTouch mats/thermostats.

ALWAYS make sure all electrical work is done by qualified persons in accordance with local building and electrical codes, Section 62 of the Canadian Electrical Code (CEC) Part I, and the National Electrical Code (NEC), especially Article 424, Part IX of the NEC, ANSI/NFPA 70.

ALWAYS use copper only as supply conductors.

ALWAYS affix the warning label (included with this manual) to the control cover plate or other location where it is easily noticed.

ALWAYS seek our help if you have a problem. If you are ever in doubt about the correct installation procedure to follow, or if the product appears to be damaged, you must call us before proceeding with the installation, or proposed repair.

If you have any questions, please view our Installation Video, visit our Web site at www.suntouch.net, or call us at **888-432-8932**.

Check heating wire resistance before installation.

Use Our LoudMouth Monitor.



We created the LoudMouth to monitor the mat during the installation process. If the mat is cut or damaged during installation, this device sounds an alarm. The LoudMouth will prevent you from burying damaged wire below hardened mortar and tile or stone.



Record the information from this nameplate label in the Mat Resistance Log at right.

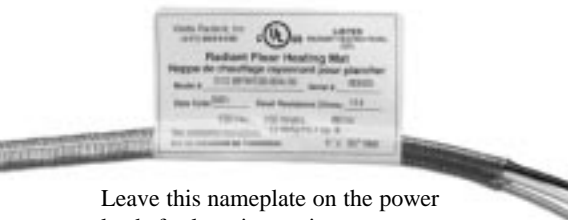

Leave this nameplate on the power leads for later inspection.

Radiant Floor Heating Mat Warning - Risk of electric shock

Electric wiring and heating panels contained below the floor. Do not penetrate floor with nails, screws, or similar devices.

The electric radiant heating warning label must be placed near, or on the face of the mat control.

Check out that wire!

Throughout the installation process it is very important to take resistance readings of the mat to make sure it is not damaged. Use a quality digital ohmmeter or multimeter to make these measurements. Analog meters (with the moving needle) are not accurate for this product.

The LoudMouth™ monitor shown at left will help constantly monitor the mat for you during the entire installation. Ask about purchasing this invaluable tool.

Essential Product and Warranty Information

There is a factory-applied nameplate label at the end of the mat and also on the cold leads as shown at lower left. Do not remove these. Record the mat serial number, mat size, voltage, and panel resistance range on the table below for each mat.

To retain the Limited Warranty as stated at the back of this manual, these items and the following measurements must be recorded, as well as all steps of this manual followed. Refer to the Limited Warranty now for complete requirements.

Measurements

Make the following measurements (as a minimum)

- before you begin installation
- after the mat is fastened to the floor
- after floor coverings are installed

Also, checking these measurements often during tile installation is highly recommended to avoid burying a damaged wire.

Checking for breaks

Measure resistance between the black and white leads (black and blue leads for 240V mats) and record this below. This measurement should be within the Mat Resistance range shown on the nameplate label, or if the label gives only a single number it must be within $\pm 10\%$. A cut or break in the wire is indicated by a resistance of "infinite" ohms (no continuity).

Checking for short-circuits

Measure resistance between the black and green leads and between the white and green leads (blue and green leads for 240V mats) and record these below. This measurement should be "infinite" ohms (no continuity). A cut or pinch in the wire is indicated by a resistance value between zero and the mat resistance.

If the resistance is not correct, or if you cut or damage the wire, quickly clean up the damaged area and call the factory for further instructions.

Mat Resistance Log

Mat Serial Number			
Mat Size			
Mat Voltage			
Factory Mat Resistance Range			
OUT OF THE BOX BEFORE INSTALLATION (ohms)			
Mat black to white			
Mat black to green			
Mat white to green			
AFTER MAT IS FASTENED TO FLOOR (ohms)			
Mat black to white			
Mat black to green			
Mat white to green			
AFTER TILE/STONE IS INSTALLED OVER THE MAT (ohms)			
Mat black to white			
Mat black to green			
Mat white to green			

Retain this log for warranty!

DO NOT DISCARD!

Phase 1. Electrical Rough-in.

Refer to all drawings on pages 11, 16, and 17 before beginning electrical work.

STEP 1.1: Install GFCI Breaker (Overcurrent Protection)

The SunTouch mat must be protected by a ground fault circuit interrupter (GFCI). This can be done either by the internal GFCI in the SunTouch FloorStat (as long as it directly controls the mat) or an indicating-type GFCI circuit breaker. This GFCI serves as a local disconnect.

Note: Follow all local building and electrical codes.

Note: It is possible to branch from an existing circuit, but this is not recommended. Please consult with a qualified electrician to determine if the circuit can handle the load and if the circuit is GFCI-protected.

The size of the breaker is determined by the total square footage of heating mat. (Depending on local codes, you may need multiple breakers for systems larger than 20 amps.)

Typical Amperage Requirement:

120 VAC SunTouch mats:

0.1 amps per sq.ft., or
10 amps per 100 sq.ft. of mat.

240 VAC SunTouch Mats:

0.05 amps per sq.ft., or
5 amps per 100 sq.ft. of mat.

STEP 1.2: Install External Contactor (relay)

Depending on the amperage requirements of the mat(s), an external contactor may be required. Consult with an electrician to determine the type and size of contactor. Do not load the FloorStat control with more than 15 amps. Be sure to protect this contactor circuit with a GFCI breaker.

STEP 1.3: Install Electrical Boxes

Thermostats are usually located near the power leads. However, they can be located almost anywhere, because the power leads and the sensor wire can be routed to electrical junction boxes and extended to a location outside the heated room (such as a utility room or basement).

Thermostat: Install a 4"-square, 2-1/8" deep electrical box with a 1-gang mud ring. Electrical boxes should be located on interior walls, typi-

cally 60" from the floor, according to NEC or other local code requirements.

Note: The FloorStat sensor wire can be extended up to a maximum of 50', if necessary.

STEP 1.4: Bottom Plate Work

Drill or saw holes at the bottom plate as indicated at right. One hole is for routing the power leads or conduit and the other is for the thermostat sensor. These holes should be directly below the electrical box(es) (see photos at right).

STEP 1.5: Install Power Lead Conduit and Thermostat Sensor

Power Lead Conduit: The armored power lead can be installed with or without electrical conduit depending on code requirements. In either case, remove one of the knock-outs in the 4" box to route the lead. If electrical conduit is not required by code, install a wire collar to secure the leads where they enter the box. If conduit is required by code, install 1/2" (minimum) conduit from the bottom plate up to the electrical box. For multiple power leads (multiple mats) install 3/4" conduit, which will accommodate multiple power leads.

Thermostat Sensor: A floor sensor comes with our FloorStat control. It can be installed in a conduit separate from the electrical power lead although this is not necessary. If a conduit is installed, the tip of the conduit should be metallic in order for the sensor to give a true temperature reading. Open a second knock-out in the bottom of the thermostat box. Feed the sensor (and conduit) through the knock-out, down through the cut-out in the bottom plate, and out into the floor where the heating mat will be installed. If you have the thermostat and sensor, install the sensor now, but wait to install the thermostat until after the mat is installed.

Note: The sensor is located in the thermostat packaging.

STEP 1.6: Rough-in Wiring

Install appropriate electrical wire (conductor) from the power source and breaker protection to the thermostat following all codes. Leave 6"-8" extra wire at the thermostat box. Refer to the Typical Wiring Diagrams at the end of this manual for help.

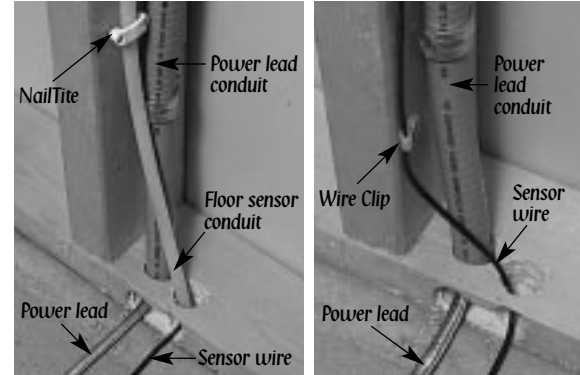

Mat Amperage Requirements

Mat Size	Square Footage	Amp Draw
120 VAC, 12"-wide mat		
12" x 10'	10 sq. ft.	1.0
12" x 15'	15 sq. ft.	1.5
12" x 20'	20 sq. ft.	2.0
12" x 25'	25 sq. ft.	2.5
12" x 30'	30 sq. ft.	3.0
12" x 35'	35 sq. ft.	3.5
12" x 40'	40 sq. ft.	4.0
12" x 45'	45 sq. ft.	4.5
12" x 50'	50 sq. ft.	5.0
120 VAC, 24"-wide mat		
24" x 5'	10 sq. ft.	1.0
24" x 10'	20 sq. ft.	2.0
24" x 15'	30 sq. ft.	3.0
24" x 20'	40 sq. ft.	4.0
24" x 25'	50 sq. ft.	5.0
24" x 30'	60 sq. ft.	6.0
24" x 35'	70 sq. ft.	7.0
24" x 40'	80 sq. ft.	8.0
120 VAC, 36"-wide mat		
36" x 5'	15 sq. ft.	1.5
36" x 6'8"	20 sq. ft.	2.0
36" x 8'4"	25 sq. ft.	2.5
36" x 10'	30 sq. ft.	3.0
36" x 15'	45 sq. ft.	4.5
36" x 20'	60 sq. ft.	6.0
240 VAC, 12"-wide mat		
12" x 20'	20 sq. ft.	1.0
12" x 30'	30 sq. ft.	1.5
12" x 40'	40 sq. ft.	2.0
12" x 50'	50 sq. ft.	2.5
240 VAC, 24"-wide mat		
24" x 10'	20 sq. ft.	1.0
24" x 15'	30 sq. ft.	1.5
24" x 20'	40 sq. ft.	2.0
24" x 25'	50 sq. ft.	2.5
24" x 30'	60 sq. ft.	3.0
24" x 35'	70 sq. ft.	3.5
24" x 40'	80 sq. ft.	4.0
24" x 45'	90 sq. ft.	4.5
24" x 50'	100 sq. ft.	5.0
24" x 60'	120 sq. ft.	6.0
24" x 70'	140 sq. ft.	7.0
24" x 80'	160 sq. ft.	8.0
240 VAC, 36"-wide mat		
36" x 10'	30 sq. ft.	1.5
36" x 13'4"	40 sq. ft.	2.0
36" x 16'8"	50 sq. ft.	2.5
36" x 20'	60 sq. ft.	3.0
36" x 30'	90 sq. ft.	4.5
36" x 40'	120 sq. ft.	6.0

Phase 2. SunTouch Installation.

MORTAR APPLICATIONS

1. THIN-SET MORTAR OVER FRAMED FLOOR (Dry-set or latex cement mortar; TCA #F144-2K)

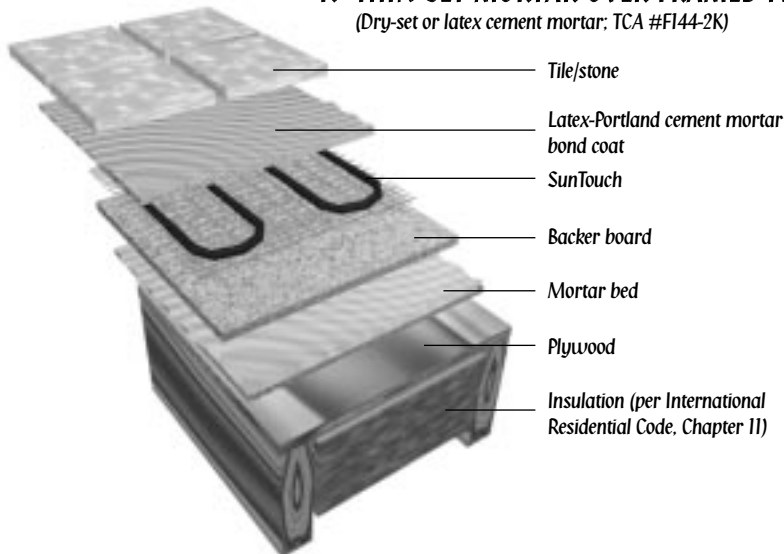

2. THIN-SET MORTAR OVER SLAB (Dry-set or latex cement on slab; TCA #I13-2K)

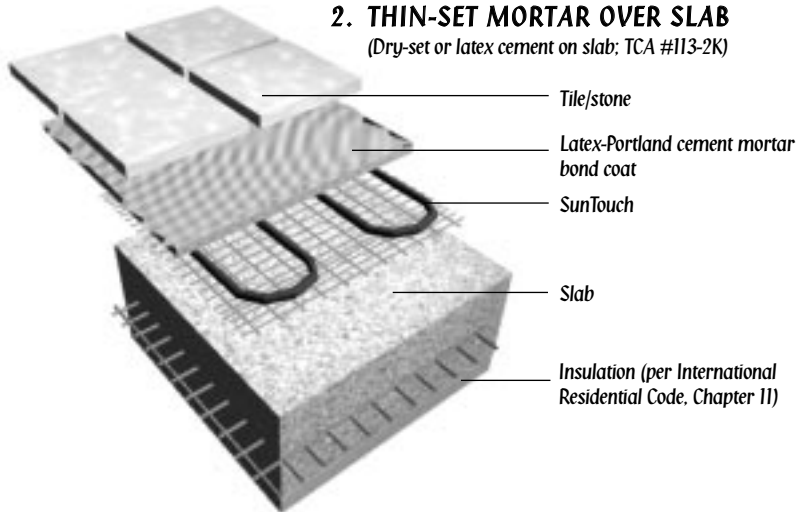

3. THICK-SET CEMENT MORTAR METAL LATH (Cement mortar metal lath; TCA #I45-2K)

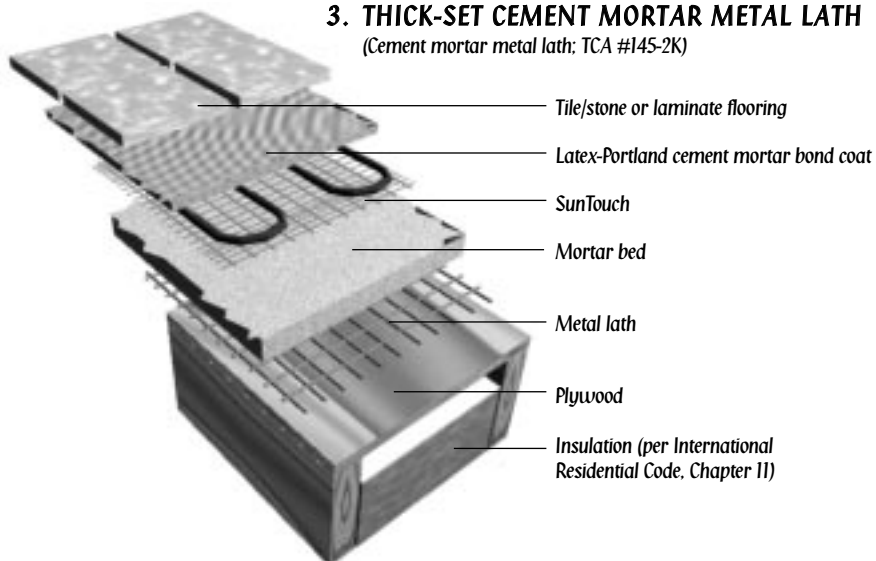

STEP 2.1

Select Type of Construction

Choose the best thin-set, thick-set, or self-leveling mortar installation detail for your application. Consult with building professionals and/or SunTouch personnel for specific details concerning proper installation.

STEP 2.2

Floor Preparation

The floor must be completely swept of all debris including all nails, dirt, wood, and other construction debris. Make absolutely sure there are no objects on the floor that might damage the SunTouch wire.

STEP 2.3

Study the Factory-supplied Items and the Design

Make sure all of the correct materials have been purchased. A general list of materials is found at the beginning of this manual.

Study the design carefully before installation. Review the thermostat location and where the mat begins and ends, as well as the general layout pattern.

Do not cut the wire or shorten the mat to make it fit the space. Doing so will cause dangerous overheating and will void the warranty!

STEP 2.4

Mortar and Thin-Slab Applications

SunTouch can be installed in two types of construction applications:

1. Thin-set or thick-set mortar beds (3/8"–1").
2. Self-leveling mortar beds (1/4"–1/2").

No matter the application, always install SunTouch before installing mortar or cement. Do not lay SunTouch in wet mortar.

We strongly recommend installing tile and stone flooring according to manufacturer's recommendations, TCA guidelines, and ANSI specifications.

If installing non-masonry floor coverings, such as hardwood, vinyl, laminate or carpet, follow industry and manufacturer's recommendations.

If installing non-masonry coverings, the best method is cover the SunTouch in a self-leveling mortar (illustrations #5 and #6).

Phase 2. SunTouch Installation.

Mortar Applications: There are two types of thin-set and two types of thick-set mortar applications illustrated on these pages.

a. If backer board or plywood sheeting is used to strengthen the floor, or if the mat will be placed directly onto the slab, install SunTouch in the thin-set mortar bond coat above these materials. See illustrations #1 or #2.

b. If a thicker mortar bed is used to strengthen the floor, SunTouch can be installed in either the mortar bed (dry-set) or in the mortar bond coat directly below the tile or stone. See illustrations #3 or #4.

In this application, SunTouch is generally installed above the self-leveling mortar in a thin-set bond coat. If you use plastic lath instead of the typical metal lath, the SunTouch can be installed in the self-leveling mortar bed.

CAUTION: If metal lath is used in the mortar bed, do not allow the SunTouch to come in direct contact with the lath because this could damage the wire.

Self-leveling Mortar Applications: There are only two approved methods of installing cement-based, self-leveling mortar beds over SunTouch. One for framed floor construction and one for slab construction (see illustrations #5 and #6). These are appropriate applications if installing engineered wood, vinyl, laminate, or carpet floor coverings. Attach the SunTouch to the subfloor or slab, then pour self-leveling mortar 1/4" to 1/2" thick according to manufacturer's specifications. Install floor covering after the mortar has cured.

Special Precautions

Isolation Membrane: Install the SunTouch above the membrane, whenever possible, unless recommended otherwise by the membrane manufacturer.

Insulation: Do not install rigid insulation directly above or below backer board or mortar. If possible, install insulation as shown in diagrams. Insulation dramatically enhances the performance and efficiency of floor-warming systems.

Mosaic Tile: When installing mosaic tile, we recommend a two-step process. First embed the SunTouch in a thin mortar bed (1/4"–3/8"), then thin-set the mosaic tile according to typical practice.

Expansion Joints: Do not install heating mats through an expansion joint. Install mats right up to the joint, if necessary, but not through the joint.

Illustrations #5 and #6 show the best method if you are installing non-masonry floor coverings.

4. THICK-SET MORTAR BED OVER SLAB

(Cement mortar bonded: TCA #F112-2K)

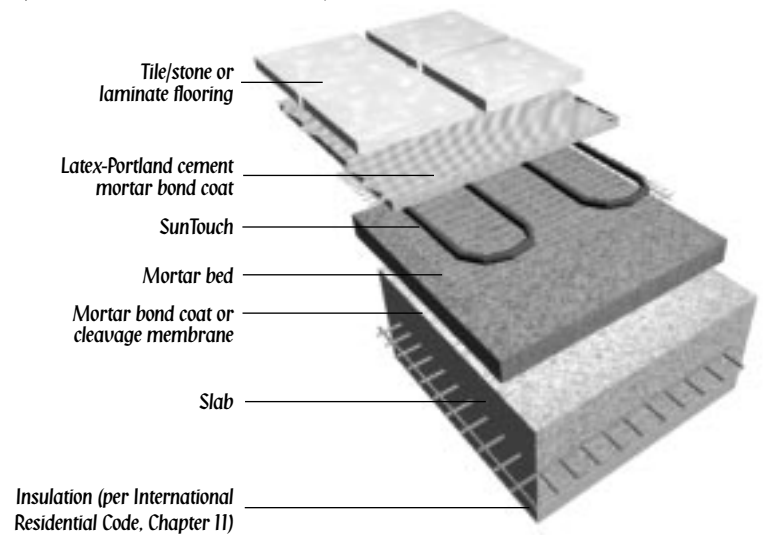

SELF-LEVELING APPLICATIONS

5. SELF-LEVELING MORTAR OVER FRAME FLOOR

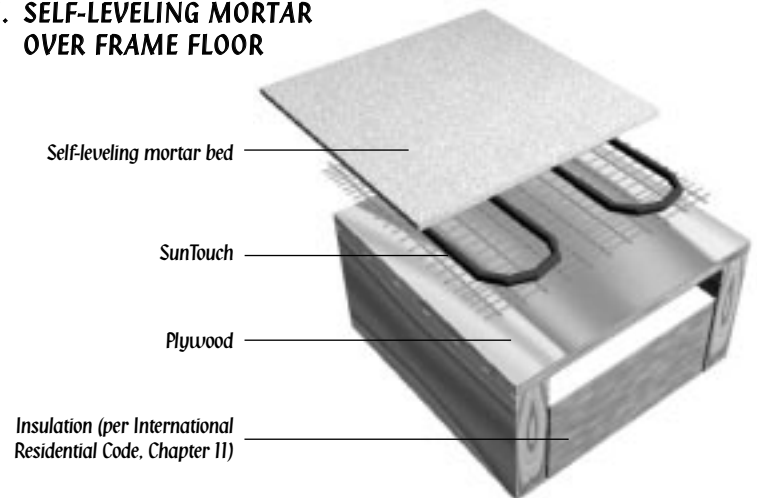

6. SELF-LEVELING MORTAR OVER SLAB ON GRADE

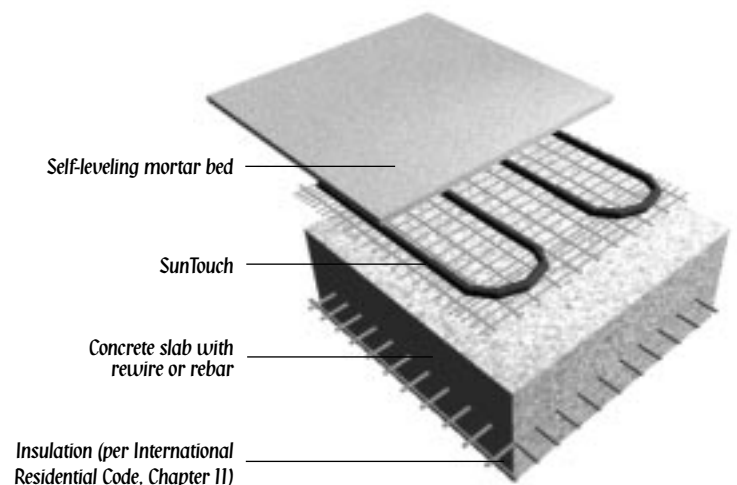

Phase 2. SunTouch Installation.

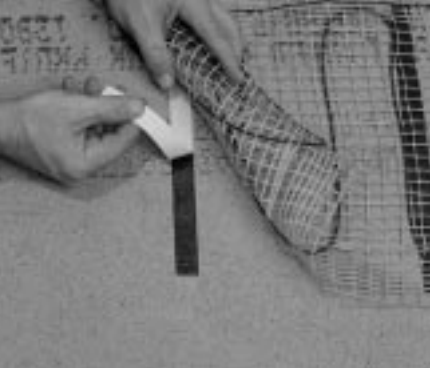

Secure mat to floor using double-sided tape...



... or staple mat in the "valleys."



Either hot glue power lead into chiseled path . . .

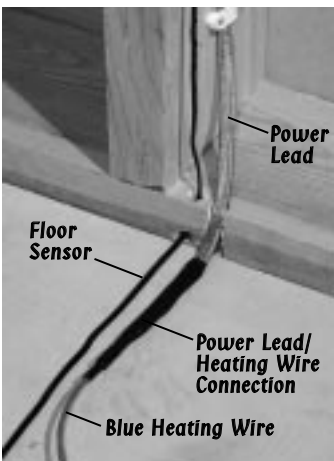

... or end power lead at floor and run blue heating wire from wall to mat.

Step 2.5 SunTouch Installation

Position the power leads near the thermostat. If this is not possible, then route the power lead through a wall and/or floor over to the location of the thermostat (follow all electrical/building codes using electrical conduit and boxes).

In all applications, double-sided tape can be used to affix SunTouch to the substrate. However, if installing SunTouch over backer board or plywood, pneumatic stapling can be faster.

Begin the installation by rolling out the mat according to the plan. At each turn or bend, stop and stretch the mat tightly to pull out the slack. Then affix the mat to the floor using double-sided tape or staples.

When using double-sided tape, apply it to the floor on 2' centers, or more, as necessary, depending on jobsite conditions. The tighter the mat, the simpler the thin-setting will be. The floor must be clear of debris for the tape to stick. Firmly rub the white, paper side of the tape before pulling off the paper. This will ensure a strong bond between the tape and the floor. Cover approximately 10 sq.ft. at a time. Use short pieces as necessary at the corners.

When using pneumatic staples, we recommend 3/8" x 1/4" chisel point staples. Initially attach the SunTouch mat every 2' to 3' on either side of the mat in the "valleys" between the blue heating wires as shown at left. By doing so it will be easier to pull up the mat and reposition, if necessary. When satisfied with the layout, go back and staple on 1' centers at either side in the "valleys" between the wires. **Proceed slowly and be very careful not to staple the blue heating wire.**

Cut or remove the orange weave as necessary to make turns. **Do not tack or staple the blue heating wire.** Install the SunTouch approximately 4"-6" away from walls, showers, tubs, toilets, drains, etc., as shown in this section and the Appendix. Install in-line with vanity and counter areas. This is because you want to make sure to get heat right up to the face of the cabinet so that toes are kept warm. Install roughly 18"-20" from back wall in toilet area. See page 9 for details.

Do not leave gaps between the mats. The heat will conduct only 1"-2" from the heating wire. SunTouch should be installed continuously across the floor as shown in the diagrams in this manual. Never install mats in a fashion causing the blue heating wires to be any closer than 2" from each other.

STEP 2.6 Shower Installation

SunTouch can be installed in shower areas, but there are several precautions that must be observed (see pg. 13 for more details).

1. Never install SunTouch in shower walls (or any other wall).

2. Never make a field splice to mats installed in shower. Do not attempt to repair or modify the mat in any way; serious hazard could result.

3. Embed mats in mortar and install only under tile, stone, brick, or other masonry surface, per this instruction manual.

4. Never begin the mat in the shower. The connection between the power lead and the blue heating wire must be fully embedded in mortar and located at least 1' away from shower openings and other areas normally exposed to water.

5. Mat controls must be located at least 4' away from shower openings such that they cannot be exposed to water or touched by a person in the shower area.

STEP 2.7 Power Lead and Factory Connection Installation

Power Lead Installation: The power lead is thicker than the SunTouch mat. If thin-setting over backer board or slab, chisel or saw a groove to recess the power lead to the level of the SunTouch. Use hot glue to secure the power lead in the groove. Or end the power lead at the floor and run just the heating wire to the beginning of the mat. **Do not damage the power lead — electrical shock could result when the mat is energized.**

Factory Connection Installation: Depending on the thickness of the mortar bed, you may need to chisel under the factory connection in order to recess the connection. **Be extremely careful not to damage the blue heating wire or connection.** A dab of hot glue will hold the connection in place.

STEP 2.8 Thermostat Sensor Installation

A sensor should be installed in the floor and routed up the wall as described in Step 1.4. Simply tuck it under the mat or weave it in between two heating wires. The sensor should extend approximately 6"-12" into the mat as shown on page 10. **Be careful not to locate the sensor near other heating sources such as a heating duct below the floor.**

CAUTION!

PROTECT THE MAT FROM TRAFFIC

If the floor covering is not immediately installed, protect the SunTouch mat by covering it with corrugated box material or plywood. Keep traffic to a minimum on the installed mat.

STEP 2.9

Mat Turns and "Fill-in" Techniques

This page contains some of the common turns and techniques used to layout around corners, angles, and built-ins.

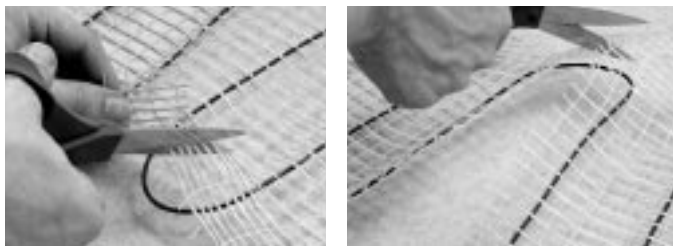

Carefully cut the orange woven mat to effect turns. Never cut, nick, or otherwise damage the blue heating wire.

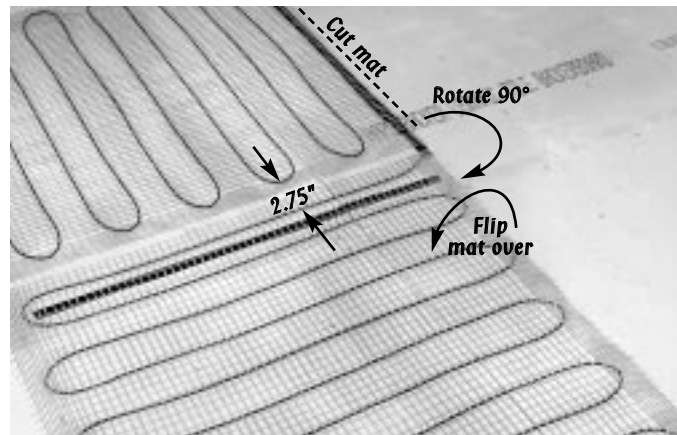

90° or Flip Turn.

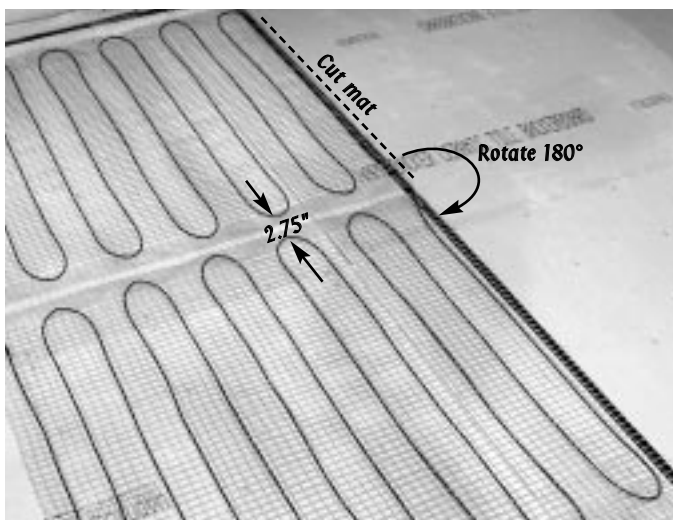

180° or Back-to-Back Turn.

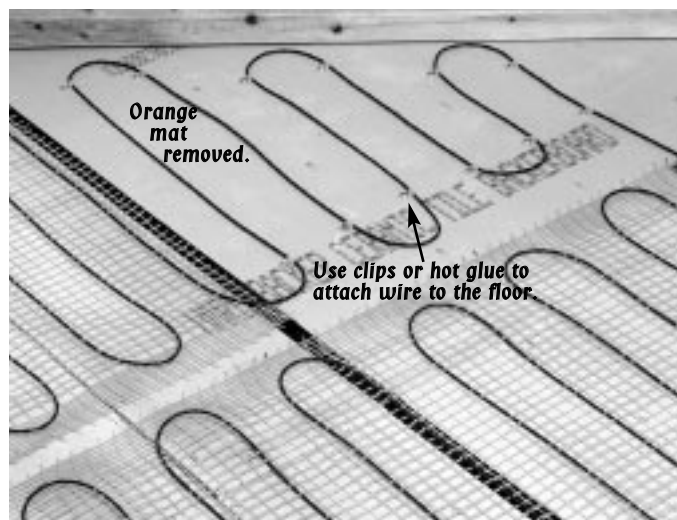

Fill-in Technique.

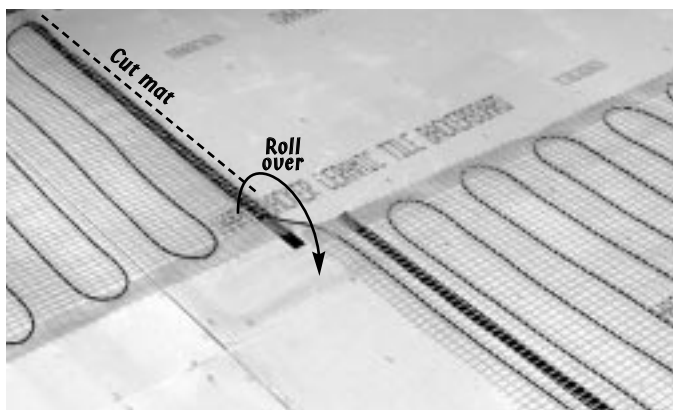

Roll-over Turn.

Installing in front of cabinets and toilets:

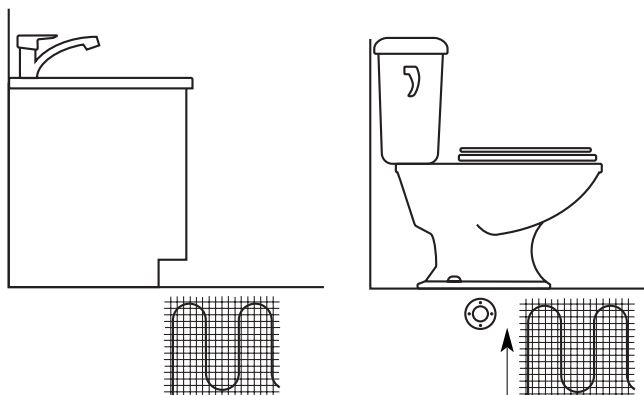

Note: Install mat right up to the face of the cabinet as shown above.

Note: Mat can be installed under tile to within 4"-6" from the front of the wax ring, and can slightly underlay the foot of the toilet if need be (approximately 20" from wall).

Phase 3. Final Floor Installation.



Keep LoudMouth monitor connected during the installation of flooring materials.



Bottom plate/sensor detail. Simply “weave” the sensor into the mat, or you may prefer to use a clip.

Radiant Floor Heating Mat Warning - Risk of electric shock

Electric wiring and heating panels contained below the floor.
Do not penetrate floor with nails, screws, or similar devices.

Apply the Warning Label (stapled to the inside cover of this manual) to the thermostat control cover plate on the control.

We recommend working with professional flooring installers to make sure proper materials are used and proper installation techniques are followed. Please note, the SunTouch Installation Video is not a flooring installation video — it only covers the installation of SunTouch floor-warming mats.

You must use a digital ohm meter to check the resistance of the mats before, during and after the installation of any floor coverings. Record the readings in the table provided on page 4, continuing to check for short circuits caused by nicks or pinches. If possible, **take photographs** of the mat installation before installing the flooring.

Warning: Never bang a trowel on the mat or the heating wire to remove excess mortar from the trowel. This could sever the heating wire.

When installing tile or stone over SunTouch, we highly recommend Tile Council of America (TCA) guidelines or ANSI specifications as a minimum standards of installation. We recommend latex-modified or epoxy-modified mortar and grout, instead of water-based multi-purpose materials.

Select the proper size trowel for the installation of tile or stone. We recom-

mend a minimum 3/8" x 1/4" trowel. This trowel works best for most 1/4" tile.

Note: Mortar beds thicker than 3/8" work fine with the performance of the system; they just take a little longer to heat up.

If you need more information on tile installation, please contact TCA at 864-646-8483 or visit their Web site at www.tileusa.com.

When installing floor coverings other than tile or stone, follow industry and/or manufacturer's recommendations. Also, make sure nails, screws, or other fasteners do not penetrate the floor in the area of SunTouch. The wire can easily be damaged by fasteners penetrating the floor.

All floor coverings must be in direct contact with the cement-based material that encase the SunTouch. Do not elevate the floor above the concrete or mortar mass below. For instance, do not install 2" x 4" wooden nailers (sleepers) on top of a slab for the purpose of attaching hardwood. This 1.5" air gap will drastically reduce the output of the heated slab. For this reason, “floating” wood/laminate floors work much better than strip hardwood flooring.

Phase 4. Final Wiring.

STEP 4.1 Install the Controls

Install the floor-sensing thermostat in the 4" square electrical box, according to the installation sheets provided with the thermostat. Connect the mat power leads, floor sensor, and power supply wiring as shown in this manual (pages 16 and 17) or in the thermostat installation sheets.

If using multiple mats, route all power leads up through the electrical conduit and into the 4" square thermostat box or separate junction box. Wire the leads in parallel (not series) — black-black, white-white, and green-green, or for 240V systems; black-black, blue-blue, green-green. Then wire a short “pig-tail” (of correctly sized wire for the load) over to the thermostat.

Use the 1-gang mud (sheet rock) ring to mount the thermostat to the electrical box.

STEP 4.2 System Start-up

After all controls are installed, do not energize the system, except to briefly test operation of all components (no longer than 10 minutes). Do not put the system into full operation until the tile or concrete installer verifies these cement materials are fully cured (typically four weeks). See thin-set manufacturer's instructions for recommended curing time.

Refer to the installation sheets provided with the controls for proper setting. The system should now operate as designed. Please leave the instruction sheets for the thermostat in a safe place for future reference.

Appendix: Installation Overview.

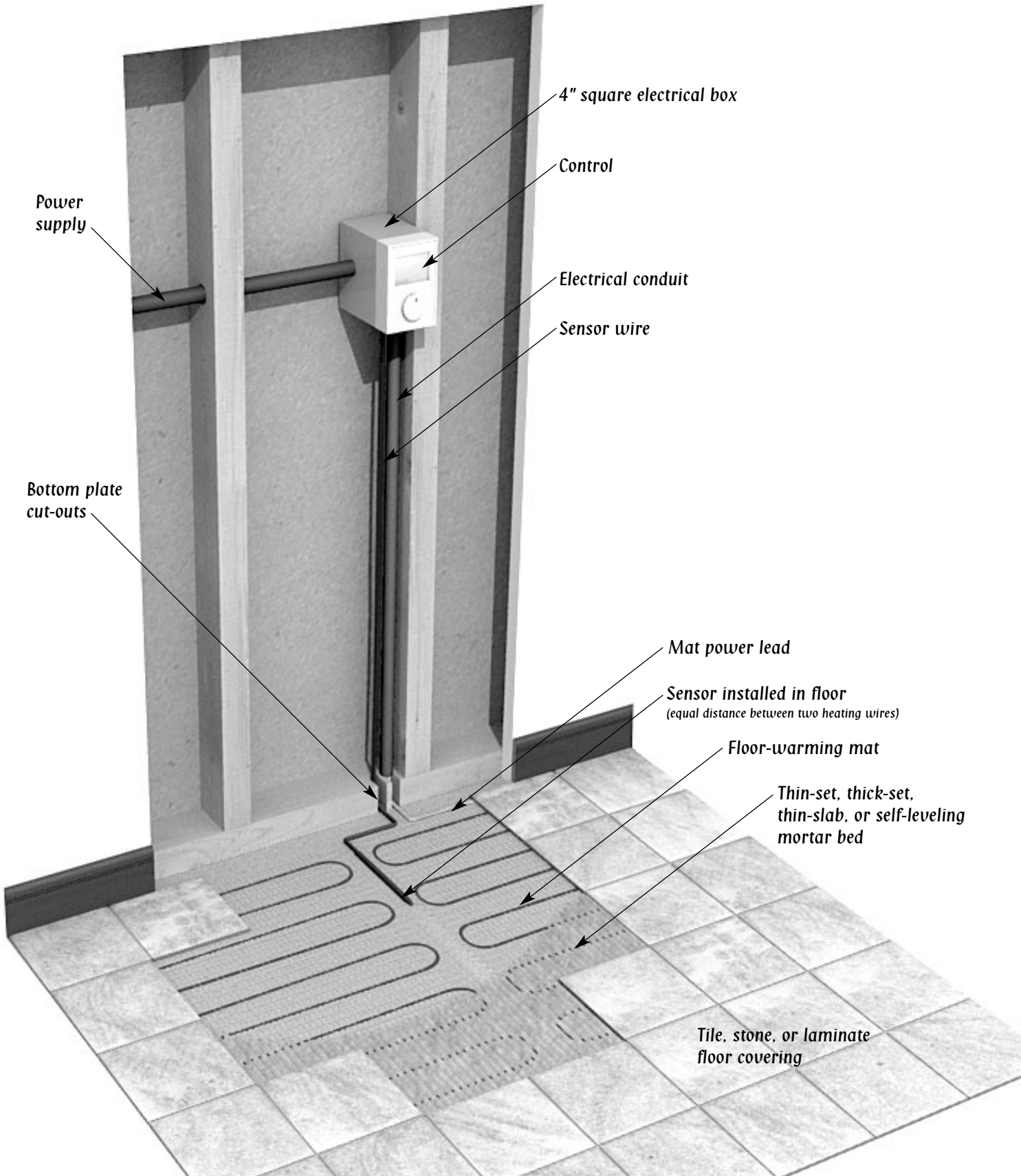

General layout of the SunTouch installation. For details, consult this manual or call us at 888-432-8932.

Appendix: Example Turns.

Types of turns

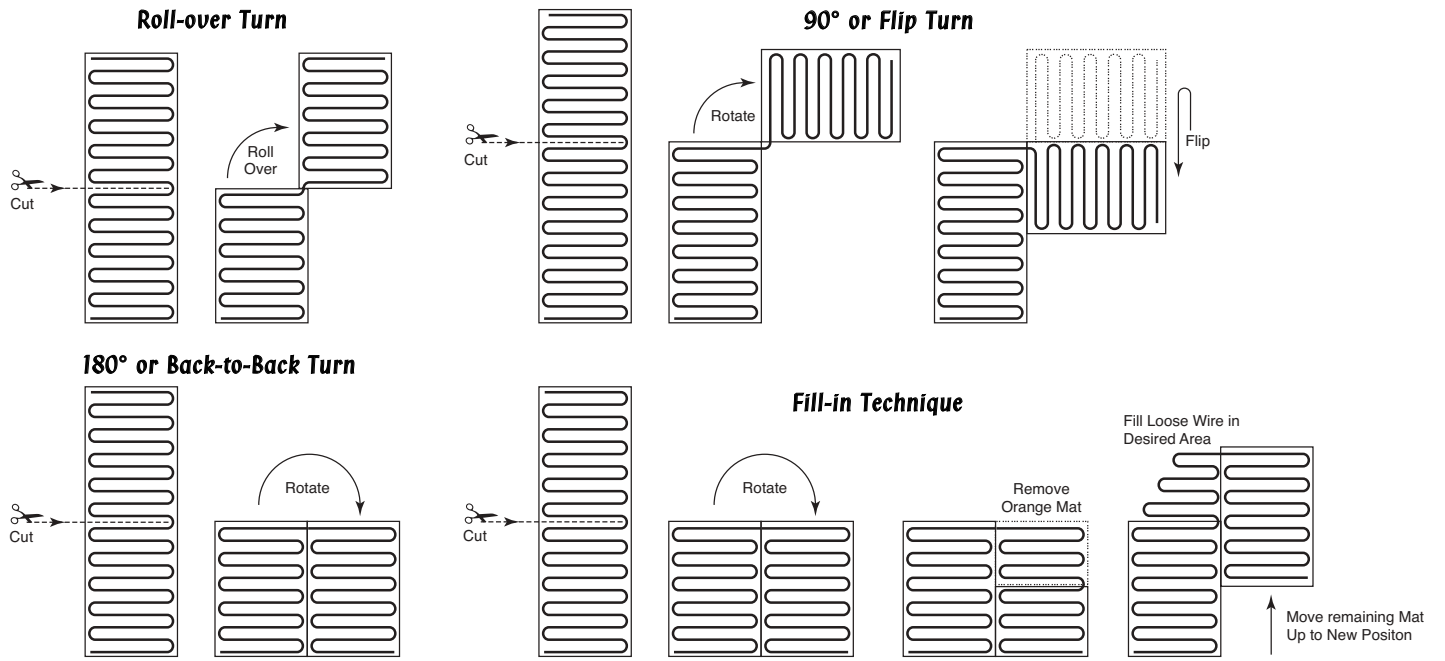

Step-by-step layout for a typical bathroom

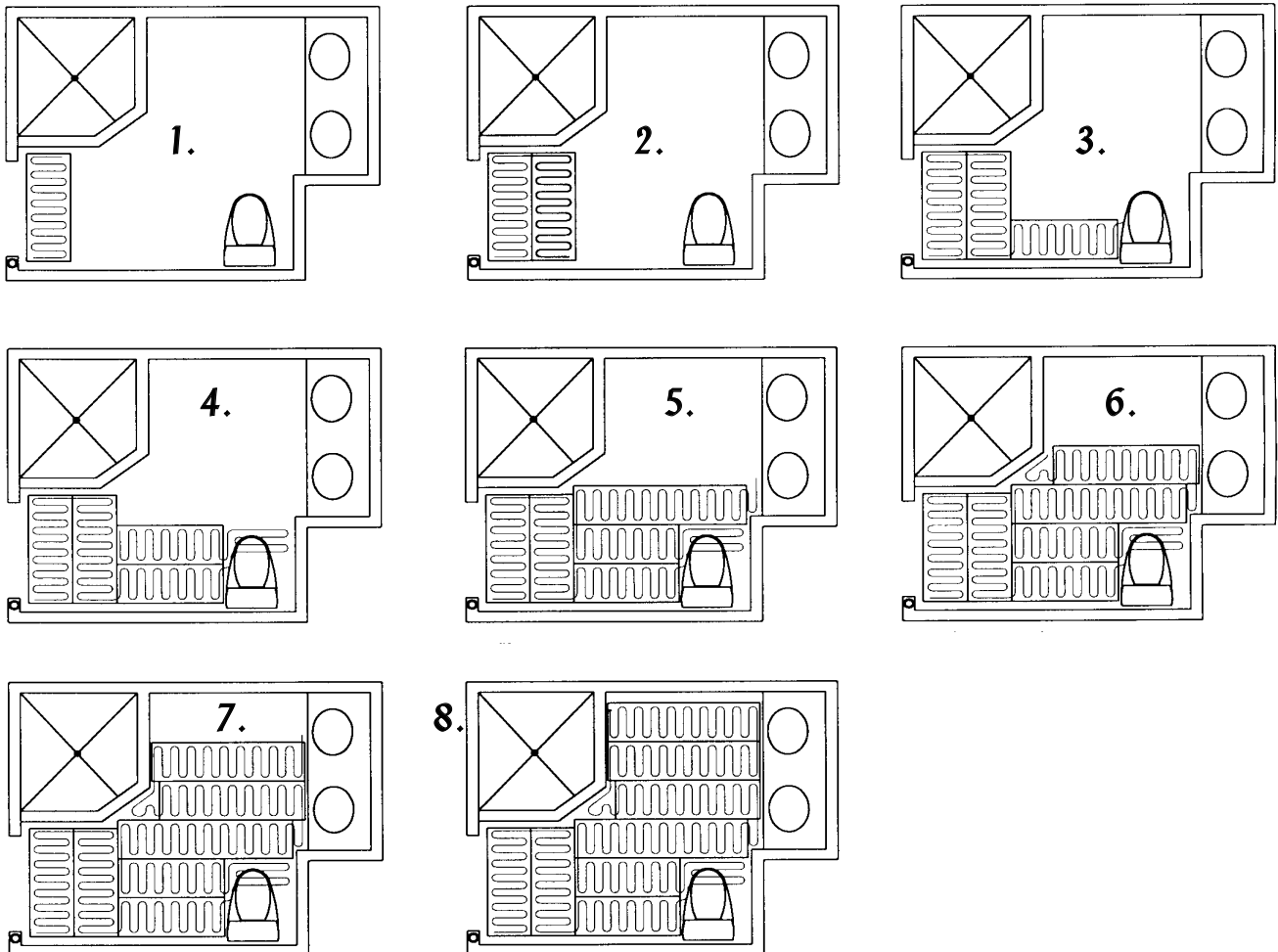

Appendix: Example Layouts.

Bathroom layout 1: One 12" x 45' mat

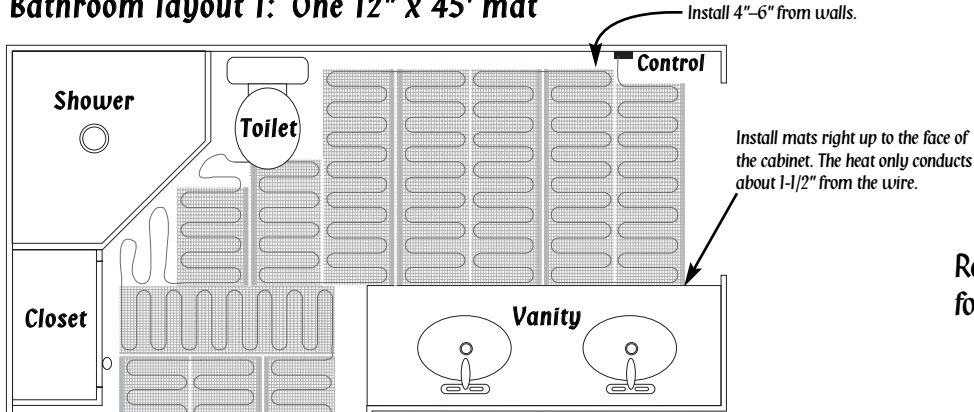

Refer to page 8 for full instructions for shower area installation.

Bathroom layout 2: One 24" x 15' mat, one 24" x 60' mat

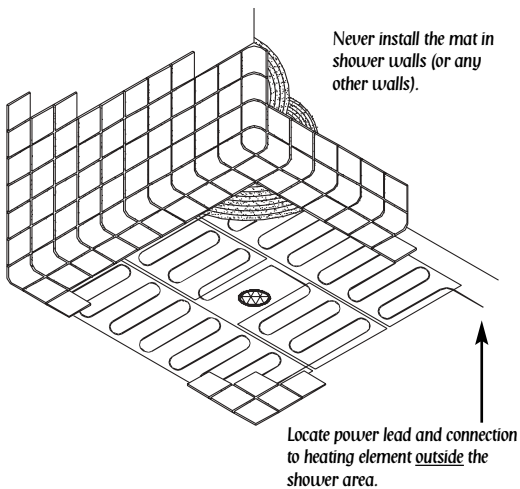
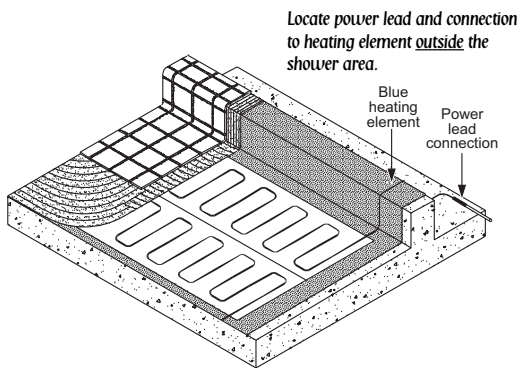
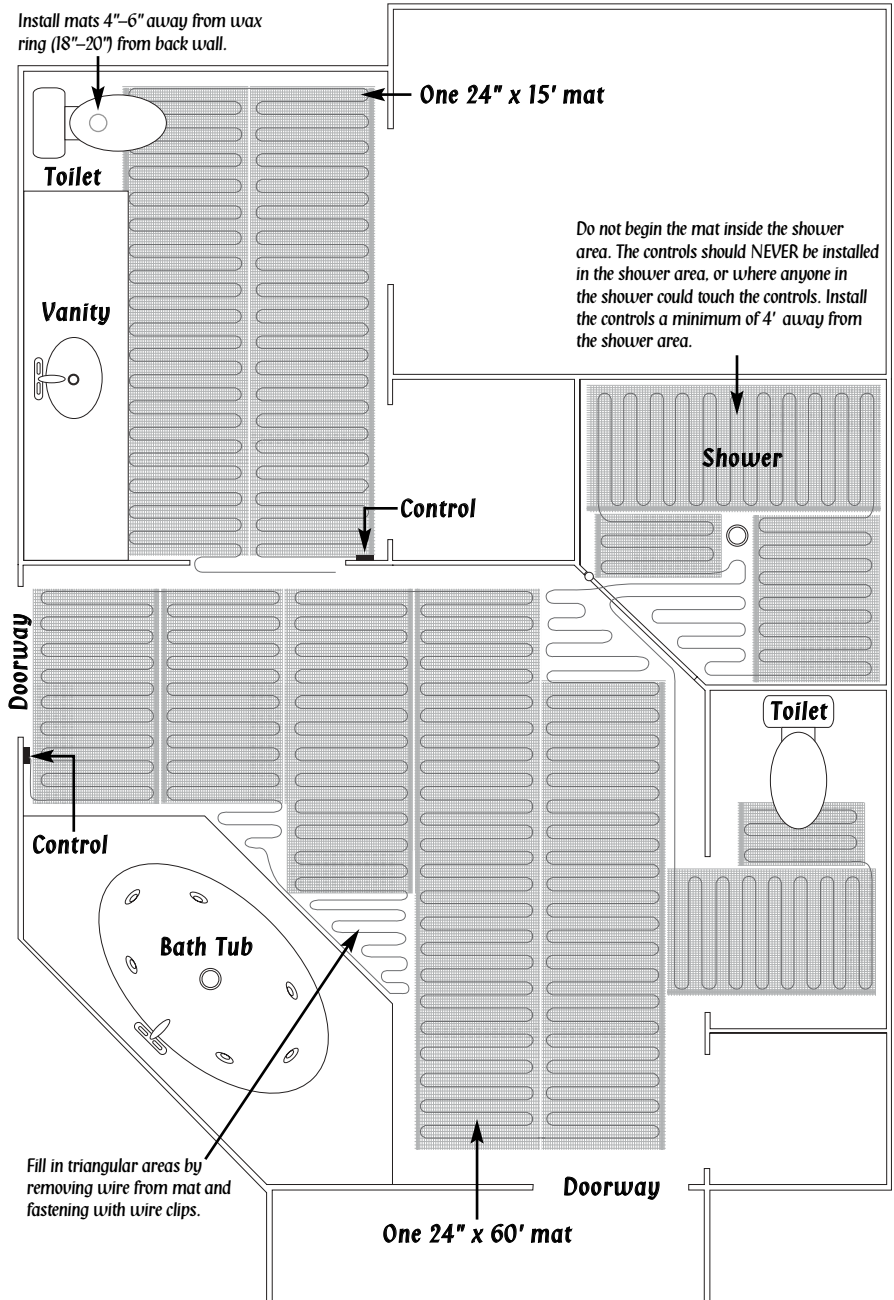

Fill in triangular areas by removing wire from mat and fastening with wire clips.

Appendix: Space-Warming Example Layouts.

Typical kitchen layout: One 24" x 25' mat, one 12" x 35' mat

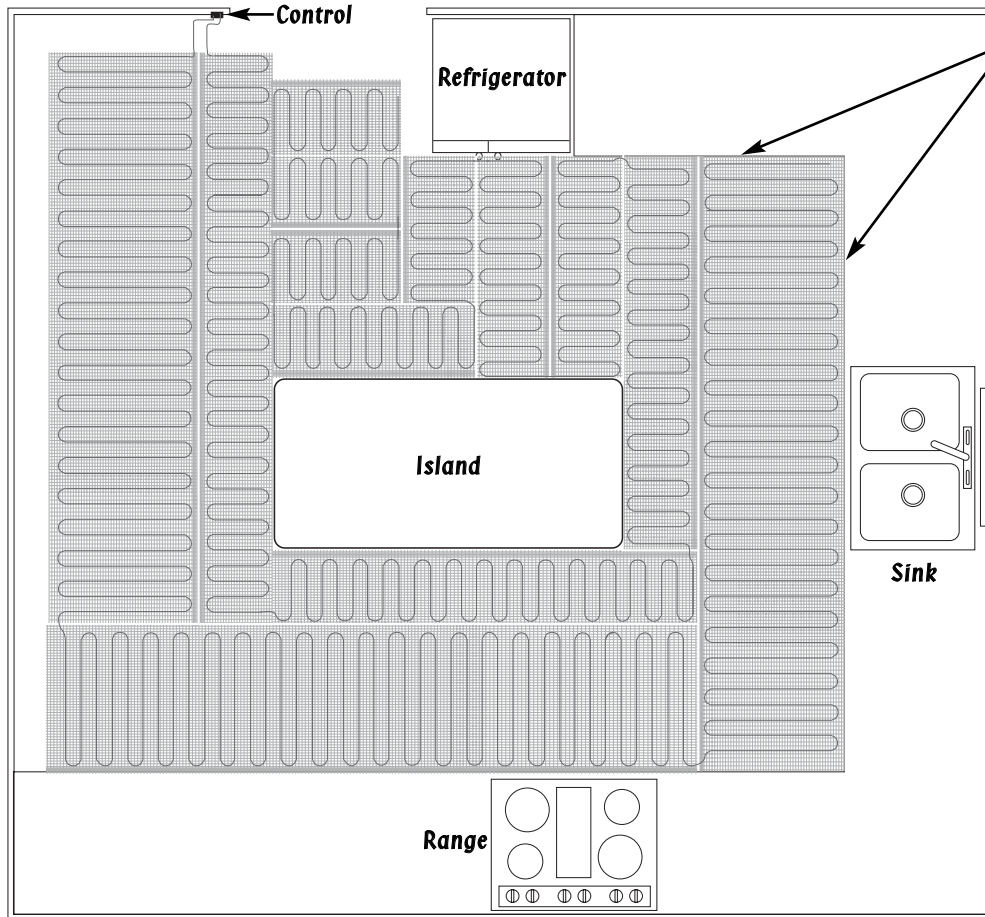

Typical mudroom layout: Two 36" x 10' mats.

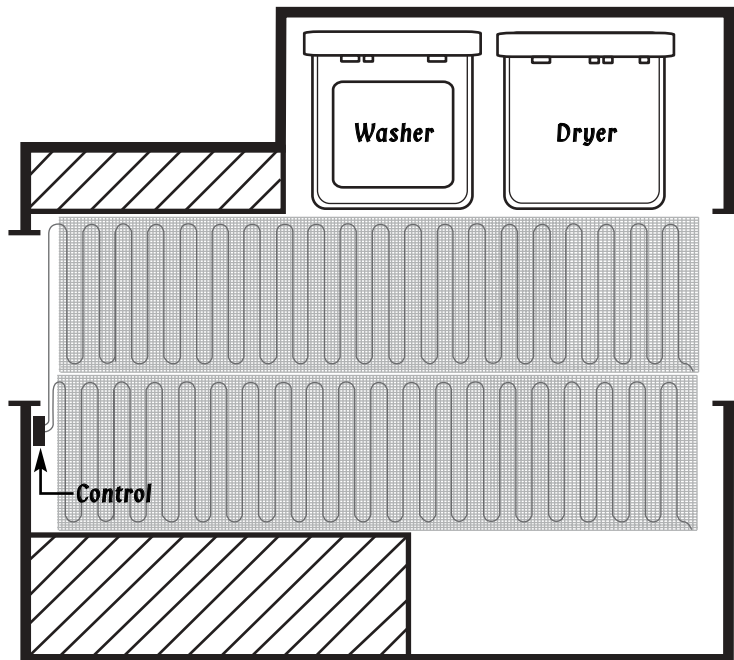

Appendix: Spot-Warming Example Layouts.

Sunroom/porch layout example: Two 36" x 6'8" mats, one 36" x 10' mat

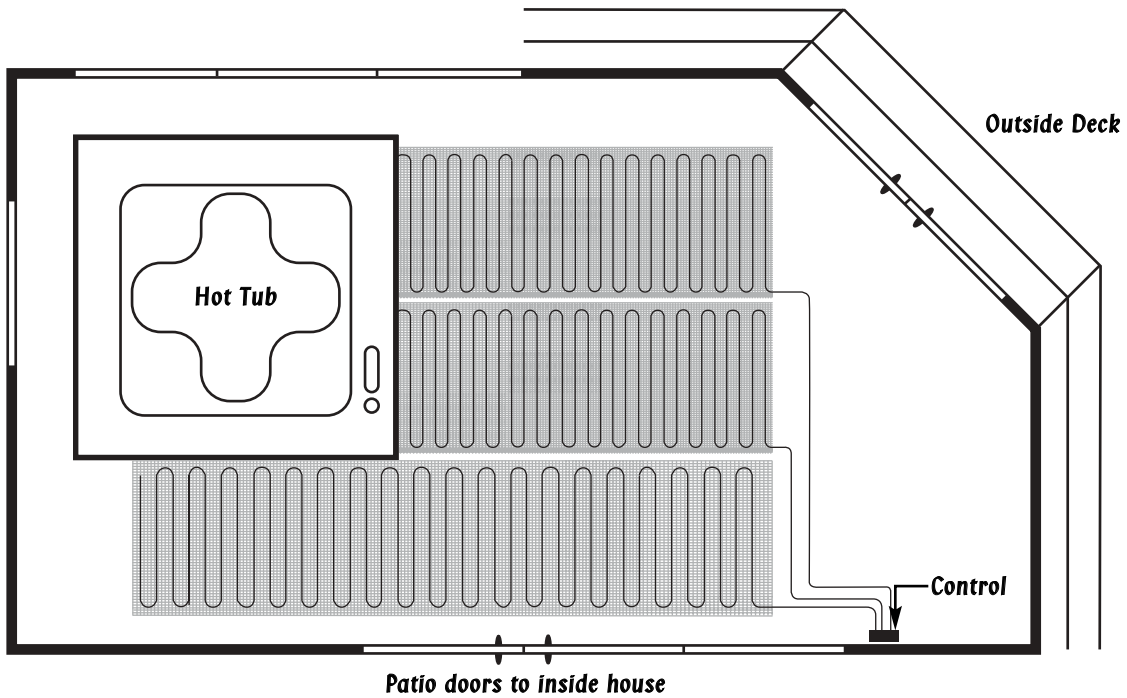

Small bath layout 1: One 36" x 5' mat

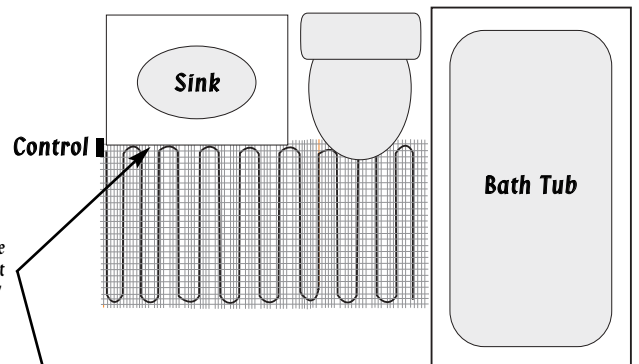

Install mats right up to the face of the vanity. The heat transfers only about 1"-2" from the wire.

Small bath layout 2: One 36" x 8'4" mat

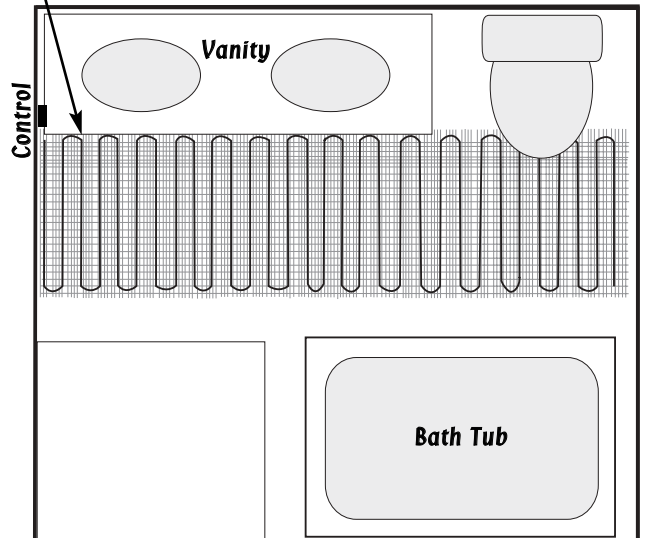

Front entryway layout:
Two 36" x 10' mats, one 36" x 5' mat

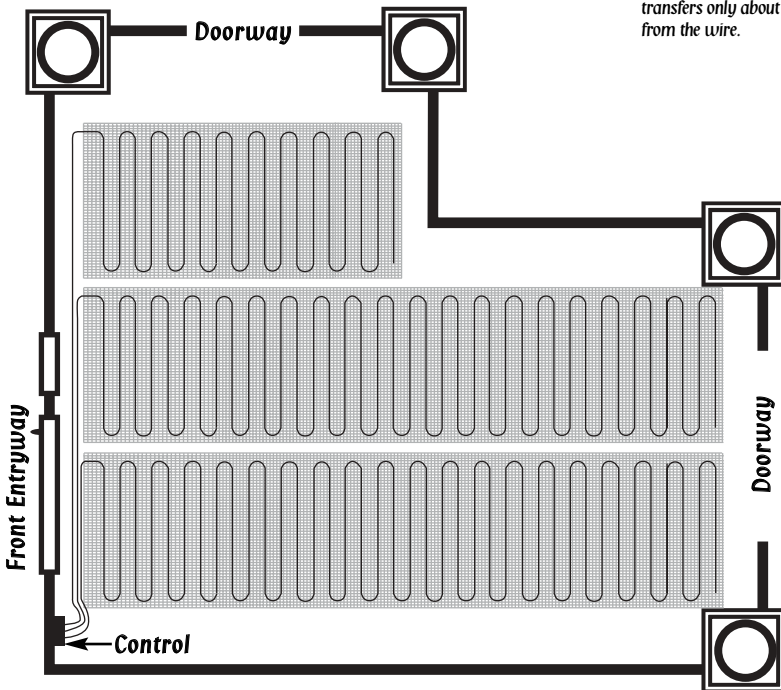

Appendix: 120V Control Wiring Diagrams.

Typical Electrical Wiring Diagram with FloorStat Controller (120V)

Dedicated 120V, 20 amp (maximum) circuit (must be GFCI protected unless GFCI FloorStat is used).

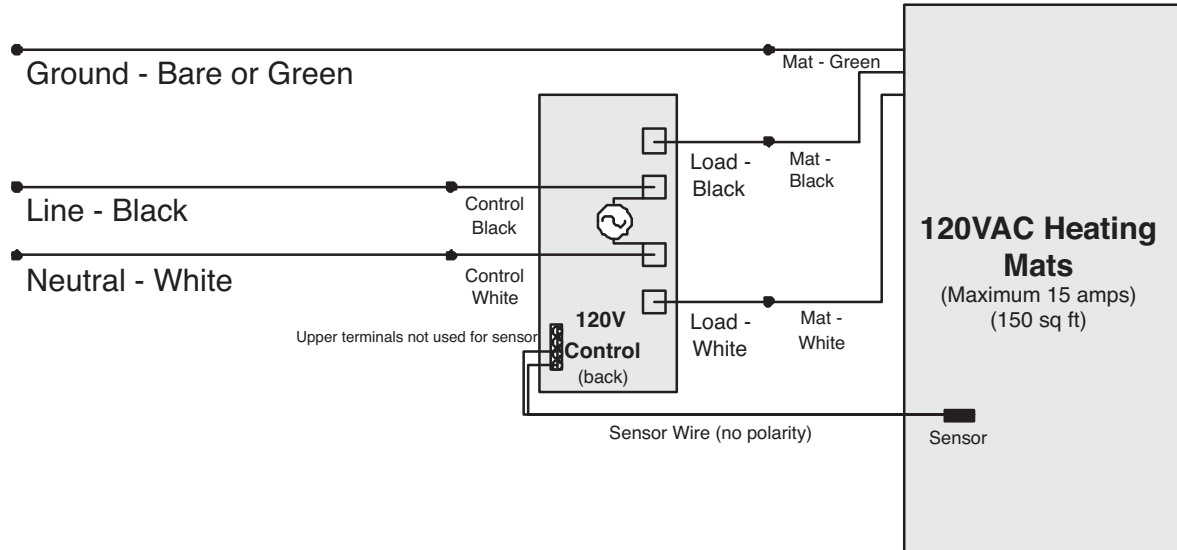

All electrical work must be done by a qualified, licensed electrician in accordance with local building and electrical codes, and the National Electrical Code (NEC), especially Article 424, Part IX of the NEC, ANSI/NFPA 70 and Section 62 of CEC Part I.

Typical Electrical Wiring Diagram with FloorStat Controller and Contactor (120V)

Dedicated 120V, 20 amp (maximum) circuit (with GFCI breaker provided by installer).

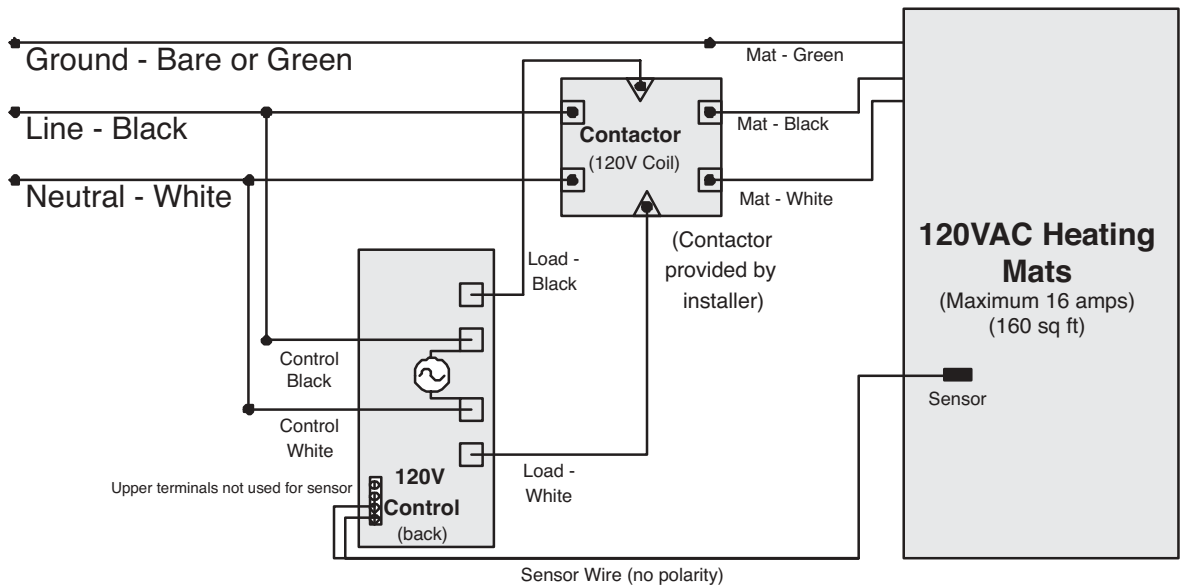

All electrical work must be done by a qualified, licensed electrician in accordance with local building and electrical codes, and the National Electrical Code (NEC), especially Article 424, Part IX of the NEC, ANSI/NFPA 70 and Section 62 of CEC Part I.

Appendix: 240V Control Wiring Diagrams.

Typical Electrical Wiring Diagram with FloorStat Controller (240V)

Dedicated 240V, 20 amp (maximum) circuit (must be GFCI protected unless GFCI FloorStat is used).

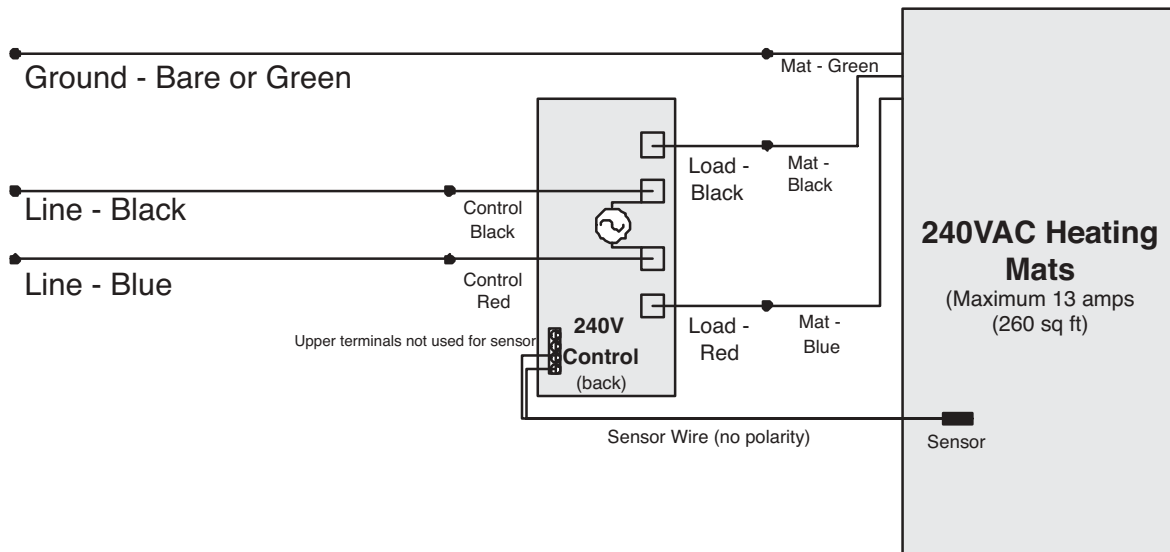

All electrical work must be done by a qualified, licensed electrician in accordance with local building and electrical codes, and the National Electrical Code (NEC), especially Article 424, Part IX of the NEC, ANSI/NFPA 70 and Section 62 of CEC Part I.

Typical Electrical Wiring Diagram with FloorStat Controller and Contactor (240V)

Dedicated 240V, 20 amp (maximum) circuits (with GFCI breaker provided by installer on circuits not protected by a GFCI FloorStat).

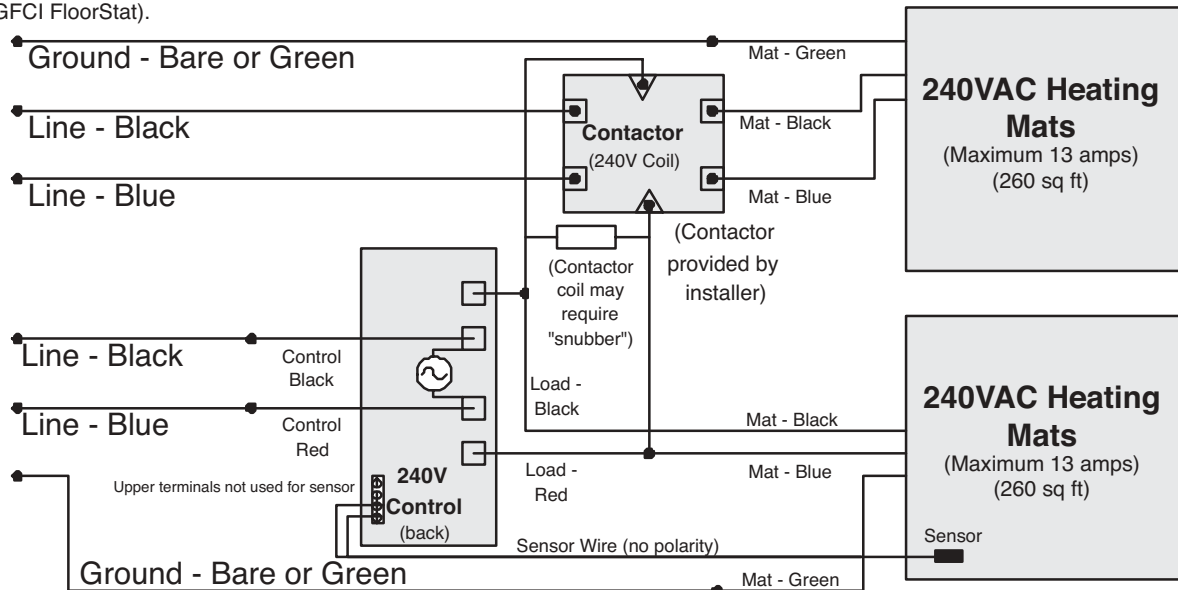

All electrical work must be done by a qualified, licensed electrician in accordance with local building and electrical codes, and the National Electrical Code (NEC), especially Article 424, Part IX of the NEC, ANSI/NFPA 70 and Section 62 of CEC Part I.

Appendix: Minimum R-values by Geographic Region.

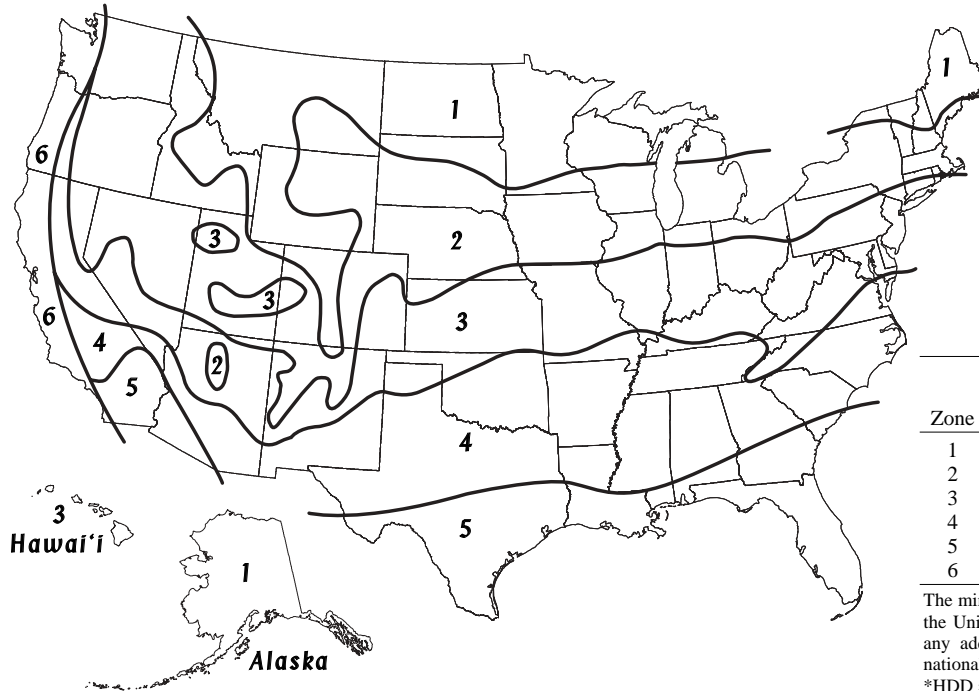

Recommended Minimum Thermal Resistances (R) of Insulation.

Zone	HDD*	Floor	Under Slab and Slab Perimeter and Depth
1	6500+	21	R-20, 4'
2	5000–6499	21	R-11, 4'
3	4000–4999	19	R-8, 3'
4	2500–3999	19	R-7, 2'
5	1500–2499	11	R-2, 2'
6	0–1499	11	R-2, 2'

The minimum insulation R-values recommended for various parts of the United States as delineated on the map of insulation zones. For any additional questions reference chapter 11 of the 2000 International Residential Building Code.

*HDD = Heating Degree Days.

Appendix: Troubleshooting SunTouch Installations.

If you are not qualified to do electrical installations, we recommend hiring a qualified, licensed electrician to install SunTouch and related electrical components. If you, or your electrician, continue to experience problems after the SunTouch installation, please read below for troubleshooting tips.

Any troubleshooting work should be done with the power removed from the circuit unless otherwise indicated.

Problem	Possible Cause	Solution
Cable resistance measurement is different than the nameplate label.	An analog-type ohm meter was used (has a needle indicator).	Obtain a digital-type ohm meter and remeasure.
	If measurement is showing an open or short circuit, cable has been damaged.	Contact the manufacturer.
	If measurement is just a little low or high, room temperature affected this resistance.	Make the room 75°–85°F, or check with the manufacturer.
The control is not working at all	No power is supplied.	Check circuit breaker; measure voltage at the control.
	Defective control.	Return to dealer for replacement.
The floor continuously heats.	Sensor is loose or broken.	If your control has a floor sensor, pull the wires loose and reinsert them. If it still does not work, measure resistance across the sensor wires. For a SunTouch control, it should be between 12,000 ohms (68°F) and 6,000 ohms (99°F).
The floor is not getting warm.	Cable has been damaged.	Measure cable resistance. Check for both open circuit and short circuit (as detailed earlier in this manual). If damaged, record all resistances and contact the manufacturer.
	GFCI is tripped.	Reset the GFCI. If it trips again, check for short circuits in the cable (as detailed earlier in this manual). If damaged, record all resistances and contact the manufacturer. If not, replace the GFCI control.
	Incorrect voltage supplied.	Measure voltage. 120V cable has black and white leads, 240V cable has black and blue leads.
	Concrete slab floor.	Surface temperatures rise slowly on slab. If it is not warmer to the touch after 5 to 8 hours of heating, check for cable damage (see “Cable has been damaged” above).
	Cables wired in series (end-to-end).	SunTouch cables must be connected in parallel if you have more than one cable (i.e., black-to-black, white-to-white).
The control is not working correctly.	Incorrect programming.	Carefully read control instructions.
	Incorrect voltage supplied.	Measure voltage at control, making sure it matches the control voltage rating.
	Sensor is disconnected or broken.	See “The floor continuously heats” above.

Limited Warranty

Watts Radiant warrants SunTouch® electric floor warming mat (“the Product”) to be free from defects in materials and workmanship for ten (10) years from the date of manufacture, provided the Product is installed in accordance with: the accompanying SunTouch Installation Manual, any special written design or installation guidelines by Watts Radiant for this project, the National Electrical Code (NEC), the Canadian Electrical Code (CEC), and all applicable local building and electrical codes. This warranty is transferable to subsequent owners.

Controls sold under the SunTouch name are warranted, parts and materials, for one year. Other controls carry manufacturer’s factory warranty.

Watts Radiant assumes no responsibility under this warranty for any damage to the Product caused by any tradespeople, visitors on the job site, or damage caused as a result of post-installation work.

The staff at Watts Radiant is available to answer any questions regarding the proper installation or application of the Product at this toll free phone number: 888-432-8932. If you are ever in doubt about the correct installation procedure to follow, or if the Product appears to be damaged, you must call us before proceeding with the installation, or proposed repair.

Under this Limited Warranty, Watts Radiant will provide one of the following remedies:

a. If the Product is determined by Watts Radiant to be defective in materials and workmanship, and has not been damaged as a result of abuse or misapplication, we will refund the cost for repair of the Product, as well as labor and materials required to repair the Product. Watts Radiant will not assume responsibility for the cost of flooring materials, or the cost to remove and replace flooring materials.

b. Or, if Watts Radiant determines the repair of the Product is not feasible, we will replace the Product or refund the original cost of the Product.

This Limited Warranty is null and void if the project owner, or his designated representative, attempts to repair the Product without receiving prior authorization. Upon notification of a real or possible problem, Watts Radiant will issue an Authorization to Proceed under the terms of this Limited Warranty.

WATTS RADIANT DISCLAIMS ANY WARRANTY NOT PROVIDED HEREIN, INCLUDING ANY IMPLIED WARRANTY OF THE MERCHANTABILITY OR IMPLIED WARRANTY OF FITNESS FOR A PARTICULAR PURPOSE. WATTS RADIANT FURTHER DISCLAIMS ANY RESPONSIBILITY FOR SPECIAL, INDIRECT, SECONDARY, INCIDENTAL, OR CONSEQUENTIAL DAMAGES ARISING FROM OWNERSHIP OR USE OF THIS PRODUCT, INCLUDING INCONVENIENCE OR LOSS OF USE. THERE ARE NO WARRANTIES WHICH EXTEND BEYOND THE FACE OF THIS DOCUMENT. NO AGENT OR REPRESENTATIVE OF WATTS RADIANT HAS ANY AUTHORITY TO EXTEND OR MODIFY THIS WARRANTY UNLESS SUCH EXTENSION OR MODIFICATION IS MADE IN WRITING BY A CORPORATE OFFICER.

DUE TO DIFFERENCES IN BUILDING AND FLOOR INSULATION, CLIMATE, AND FLOOR COVERINGS, WATTS RADIANT MAKES NO REPRESENTATION THAT THE FLOOR TEMPERATURE WILL ACHIEVE ANY PARTICULAR TEMPERATURE, OR TEMPERATURE RISE. UL® STANDARD LISTING REQUIREMENTS LIMIT THE HEAT OUTPUT OF SUNTOUCH MATS TO 12 WATTS PER SQUARE FOOT, AND AS SUCH, USERS MAY OR MAY NOT BE SATISFIED WITH THE FLOOR WARMTH THAT IS PRODUCED. WATTS RADIANT DOES WARRANT THAT ALL MATS WILL PRODUCE THE RATED WATT OUTPUT LISTED ON THE MAT NAMEPLATE, WHEN OPERATED AT THE RATED VOLTAGE.

Some states do not allow the exclusion or limitation of incidental or consequential damages and some states do not allow limitations on how long implied warranties may last. Therefore, the above limitations or exclusions may not apply to you. This warranty gives you specific legal rights and you may also have other rights which vary from state to state.

Terms and Conditions

Shipping Discrepancies: Incoming materials should be inventoried for completeness and for possible shipping damage. Any visible damages or shortages must be noted prior to accepting the material. Once the receiving personnel accepts the material on their dock, they have relieved the freight company of any responsibility. Any discrepancy concerning type or quantity of material shipped, must be brought to the attention of Watts Radiant within 15 days of the shipping date entered on the packing slip for the order.

Return Policy: Watts Radiant items may be returned, if they are not damaged or used. There will be a 25% restock charge applied to items returned due to overstock or customer order error. All returned items must not be damaged and in new condition. SunTouch heating mats, controls or other parts that have a quality defect will be replaced (not credited) at no charge to the customer. If an item is shipped in error, there will be no restocking charge. All items returned, for either replacement, credit or repair, must have a Returned Goods Authorization (RGA) number, or they will not be accepted. Please call our order desk for an RGA number. Products older than 180 days are excluded from these terms and conditions and may not be returned.

Products that have been damaged or heating mat(s) that have been cut, may not be returned. This includes mat that has had mortar or concrete materials applied to them. These materials cannot be repaired and cannot be resold; therefore, we cannot accept them.

Please note: Watts Radiant offers free repair to mats (heating elements) that are damaged in the field. Ship the mat to Watts Radiant and we will repair it and ship it back at no charge. This offer does not apply to controls. You must call and ask for a Returned Goods Authorization (RGA) number before shipping damaged mats back to us.

Mat layout grid — use this to draw a scaled layout of your room



WATTS

SunTouch

888-432-8932 (USA and Canada)

417-831-4067 (Fax)

w w w . s u n t o u c h . n e t